

Segregator UNITO 600
 Trash bin UNITO 600
 Сегрегатор UNITO 600

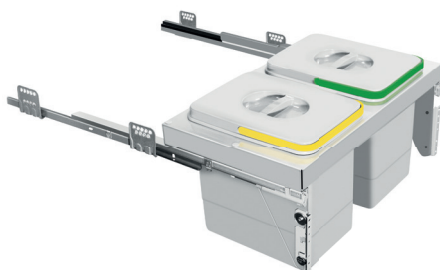

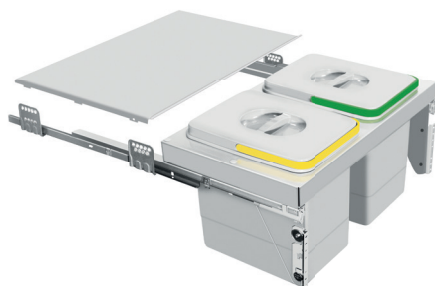



PB-91554160V

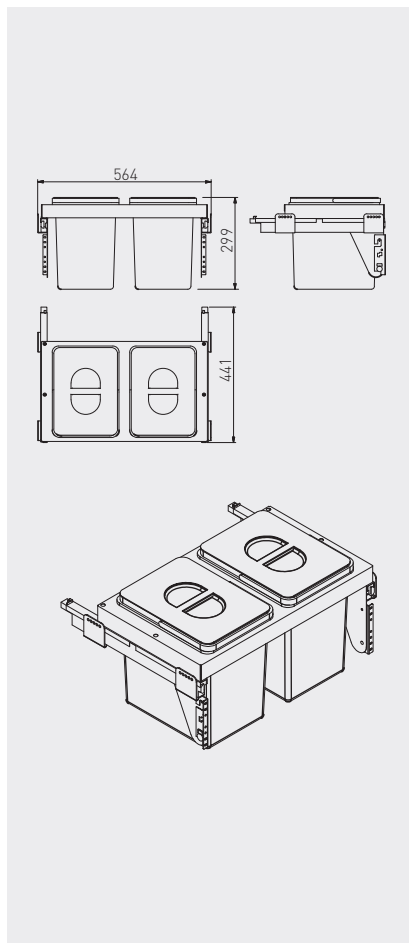

PB-91564160V



Z mocowaniem przednim. Na prowadnicach z cichym domykiem
 With door mount bracket. On ball bearing slides with soft closing
 Крепление к фасаду. Направляющие с доводчиком

				
PB-91554160V	600	2 x 15 L	szary gray серый	tworzywo plastic пластмасса
PB-91564160V		2 x 15 L, pokrywka / cover / крышка		

